



Overview: model class **Q-CLASSIC-30**

Safe and approved storage of flammable hazardous substances in working areas



Price-performance winner

- the sophisticated design and the use of melamine-resin-coated, fireproof special plates ensures an optimum price/performance ratio for the Q-CLASSIC-30



High flexibility

- integrated transport base for simple inhouse transport
- cabinet can be transported upright through doors (all Q-LINE models)
- adjustable feet installed in the base allow the safe and fast compensation of minor surface unevenness



Warranty up to 5 years

- quality from which you benefit
- you get an extended manufacturer's warranty of up to 5 years on the Q-CLASSIC-30 cabinets

Further features of this model class



Modern bicolour design

- the Q-CLASSIC brings colour to your workplace: choice of seven door colours at no extra cost
- language-free labelling for optimum international usability

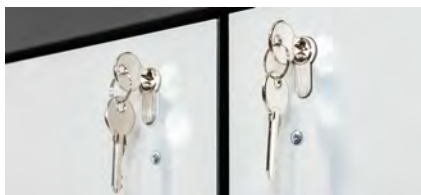

Cylinder lock

- door lockable with cylinder lock, the cabinets can be integrated by the customer in an existing locking system

Possible interior equipment



- **metal-free interior equipment** for the storage of aggressive hazardous materials
- as standard with **removable plastic sump**



- **drawers** with high storage volumes, ideal for storing small containers



- **height-adjustable shelves** in different versions



- **bottom collecting sump** – safe collection of leakages
- usable as storage level in conjunction with perforated insert



Safety storage underbench cabinets for the storage of flammable hazardous materials in working areas according to EN 14470-1 and TRGS 510



CLASSIC



- **fire resistance of 30 minutes** (type 30), type-tested in accordance with EN 14470-1



- **GS-tested** (EN 14470-1, EN 14727, document EK5/AK4 09-10, ProdSG)
- **50,000** wear-free opening and closing actions
- test basis: all cabinets of this model group correspond to the requirements of the Equipment and Product Safety Act (§7 Para. 1) with respect to the guarantee of safety and health



- all cabinets of this model group have been successfully tested in accordance with **FM test standard 6050** and are compliant to NFPA Code 30, NFPA 1 Fire Code, OSHA



- **excellent products with special manufacturer warranty**
- extended **manufacturer warranty of up to 5 years** in combination with the asecos BASICPlus tariff

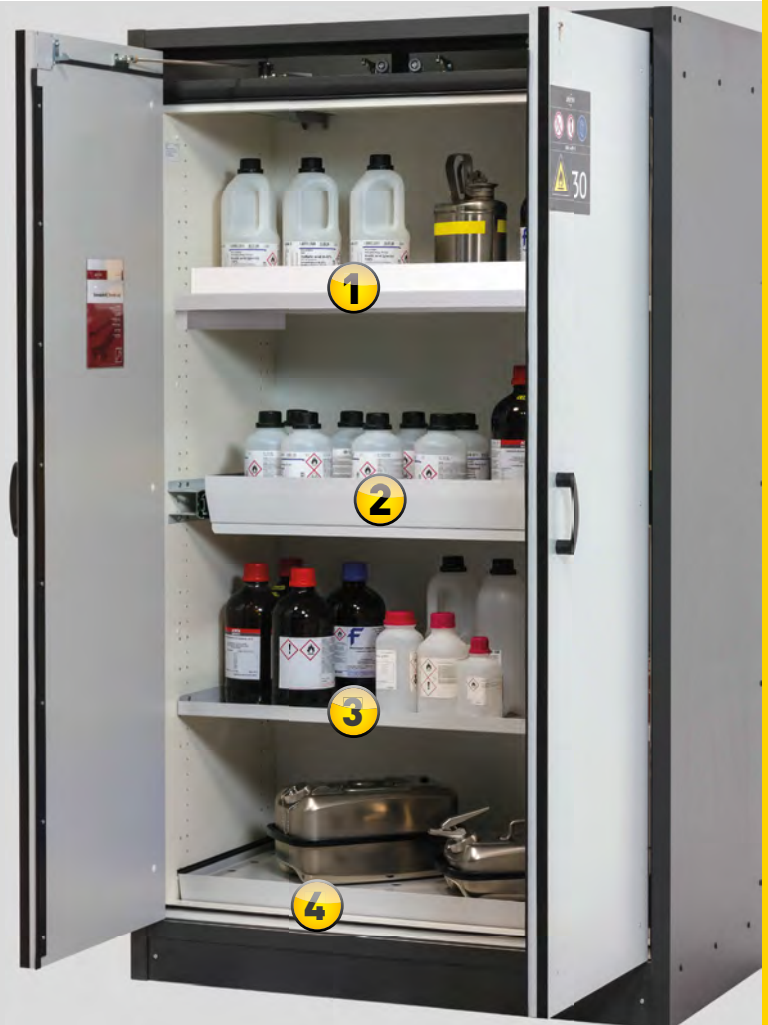



Q-CLASSIC-30 ◀ 116 cm ▶

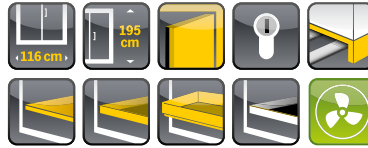

Safe and approved storage of flammable hazardous substances in working areas

Function / construction:

- **robust construction and longevity:** triple hinged door, cabinet body made of melamine resin and flame retardant special plates, safety elements assembled outside the storage compartment for increased protection against corrosion, doors with metal front as well as scratch- and impact-resistant surface, easy to clean
- **easy handling with comfort:** doors stop in any position, self-closing in the event of fire
- **no unauthorised use:** doors lockable with profile cylinder (integration in an existing locking system possible)
- **easy transport:** integrated transport base with removable, optional base cover or adjusting aids with base cover

- **ventilation:** integrated air ducts ready for connection (DN 75) to a technical exhaust system

Available equipment

- shelves with load capacity of 75 kg
- tray shelves with load capacity of 150 kg
- perforated insert useable as storage area
- bottom collecting sump
- drawers – high storage capacity, optimal use of the available storage capacities
- drawers heavy-duty with load capacity of 100 kg
- metal-free tray shelves and collecting sumps
- storage box
- sump inliner (PE or PP)

Safety storage cabinet

Q-CLASSIC-30 model Q30.195.116

Body colour Anthracite grey, with wing doors in Warning yellow (RAL 1004), interior equipment with 3 x shelf, 1 x perforated insert, 1 x bottom collecting sump (sheet steel powder-coated)

Order No. 31003-060-33635

(base cover and recirculating air filter system optional)



Maximum flexibility

No problem with the Q-CLASSIC-30 including transport base and technical ventilation with recirculating air filter system (optional), Q-Mover (optional) for in-house transport



Drawers

High storage capacity
Ideal for the storage of small containers



Extraction unit

Safe ventilation of safety storage cabinets

plug-in – fast and easy to install

Further information and products from page 397

Order No. 14218



Recirculating air filter system

Avoid complex wall breakthroughs and expensive extraction piping

Further information from page 393

Order No. 25099



Safety storage cabinet

Q-CLASSIC-30 model Q30.195.116

Body colour Anthracite grey, with wing doors in Light grey (RAL 7035), interior equipment with 4 x drawer (sheet steel powder-coated)

Order No. 31003-061-33647

(base cover optional)

Safety storage cabinet

Q-CLASSIC-30 model Q30.195.116

Body colour Anthracite grey, with wing doors in Gention blue (RAL 5010), interior equipment with 6 x drawer (sheet steel powder-coated)

Order No. 31003-067-33649

(base cover and recirculating air filter system optional)

7 door colours are available **at no extra cost:**



Order example - how to order correctly



| Model | Information / equipment | Order No. |
|-------------|----------------------------|-----------|
| Q30.195.116 | without interior equipment | 31003 |

| Body colour | Door colour | Order No. |
|-----------------|-------------------------|-----------|
| Anthracite grey | Warning yellow RAL 1004 | 060 |
| Anthracite grey | Light grey RAL 7035 | 061 |
| Anthracite grey | Traffic red RAL 3020 | 066 |
| Anthracite grey | Gention blue RAL 5010 | 067 |
| Anthracite grey | Reseda green RAL 6011 | 068 |
| Anthracite grey | asecos silver | 069 |
| Anthracite grey | Pure white RAL 9010 | 070 |

| Interior equipment packages (can only be ordered in combination with the cabinet) Material | Order No. |
|--|-------------------------------|
| 3x shelf, 1x perforated insert, 1x bottom collecting sump (V=33.0L) | old code 30003 new code 33635 |
| 4x shelf, 1x perforated insert, 1x bottom collecting sump (V=33.0L) | 30004 33636 |
| 3x shelf, 1x bottom collecting sump (V=33.0L) | 30005 33637 |
| 4x shelf, 1x bottom collecting sump (V=33.0L) | 30006 33638 |
| 3x tray shelf (V=33.0L), 1x perforated insert, 1x bottom collecting sump (V=55.5L) | 30007 33640 |
| 3x shelf, 1x perforated insert, 1x bottom collecting sump (V=33.0L) | 30008 33642 |
| 4x shelf, 1x perforated insert, 1x bottom collecting sump (V=33.0L) | 30009 33643 |
| 3x shelf, 1x bottom collecting sump (V=33.0L) | 30010 33644 |
| 4x shelf, 1x bottom collecting sump (V=33.0L) | 30011 33645 |
| 3x tray shelf (V=33.0L), 1x bottom collecting sump (V=33.0L) | 30013 30013 |
| 4x tray shelf (V=33.0L), 1x bottom collecting sump (V=33.0L) | 30014 30014 |
| 4x drawer (V=30.0L) | 30015 33647 |
| 5x drawer (V=30.0L) | 30016 33648 |
| 6x drawer (V=30.0L) | 30017 33649 |
| 4x drawer (V=30.0L) | 30018 33651 |
| 5x drawer (V=30.0L) | 30019 33652 |
| 6x drawer (V=30.0L) | 30020 33653 |



Individual configuration of model Q30.195.116

| Model | Information / equipment | W x D x H (mm) | Order No. |
|-------------|----------------------------|-------------------|-----------|
| Q30.195.116 | without interior equipment | 1164 x 620 x 1947 | 31003 |

| Body colour | Door colour | Order No. |
|-----------------|-------------------------|-----------------------|
| Anthracite grey | Warning yellow RAL 1004 | 060 4 |
| Anthracite grey | Light grey RAL 7035 | 061 4 |
| Anthracite grey | Traffic red RAL 3020 | 066 4 |
| Anthracite grey | Gentian blue RAL 5010 | 067 4 |
| Anthracite grey | Reseda green RAL 6011 | 068 4 |
| Anthracite grey | asecos silver | 069 4 |
| Anthracite grey | Pure white RAL 9010 | 070 4 |

| Interior equipment | Material | W x D x H (mm) | 1) | 2) | 3) | Order No. | |
|---------------------------------------|---------------------------------------|-------------------|--------|-------|-------|-----------|--------------------------|
| | | | | | | old code | new code |
| shelf | sheet steel powder-coated RAL 7035 | 1040 x 432 x 30* | 75.00 | | | 30021 | 30021 2 |
| | stainless steel | 1038 x 425 x 29* | 75.00 | | | 30024 | 30024 2 |
| tray shelf | sheet steel powder-coated RAL 7035 | 1025 x 445 x 71* | 150.00 | 33.00 | 30.00 | 30028 | 30028 2 |
| | stainless steel | 1025 x 445 x 71* | 150.00 | 33.00 | 30.00 | 30064 | 30064 2 |
| tray shelf, metal-free | PP grey | 1002 x 472 x 74* | 50.00 | 33.00 | 30.00 | 30027 | 30027 2 |
| perforated insert | sheet steel powder-coated RAL 7035 | 1024 x 417 x 60 | 75.00 | | | 5536 | 5536 2 |
| | stainless steel | 1024 x 417 x 60 | 75.00 | | | 5773 | 5773 2 |
| perforated insert, height = 135 mm | sheet steel powder-coated RAL 7035 | 1024 x 417 x 135 | 135.00 | | | 14084 | 14084 2 |
| bottom collecting sump | sheet steel powder-coated RAL 7035 | 1024 x 489 x 86* | | 33.00 | 30.00 | 30022 | 33634 2 |
| | stainless steel | 1024 x 489 x 86* | 150.00 | 33.00 | 30.00 | 30025 | 33641 2 |
| bottom collecting sump, V = 55,5 ltr. | sheet steel powder-coated RAL 7035 | 1017 x 482 x 127* | | 55.50 | 50.45 | 30023 | 33639 2 |
| | stainless steel | 1018 x 438 x 120* | | 55.50 | 50.00 | 30026 | 30026 10 |
| bottom collecting sump, metal-free | PP grey | 1002 x 472 x 74* | | 33.00 | 30.00 | 26989 | 26989 2 |
| drawer | sheet steel powder-coated RAL 7035 | 844 x 488 x 90* | 60.00 | 30.00 | 2727 | 30013 | 33646 2 |
| | stainless steel | 844 x 488 x 90* | 60.00 | 30.00 | 2727 | 30033 | 33650 2 |
| drawer (heavy-duty) | sheet steel powder-coated RAL 7035 | 843 x 487 x 162* | 100.00 | 66.00 | | 30032 | 30032 4 |
| | stainless steel | 843 x 487 x 162* | 100.00 | 66.00 | | 30034 | 30034 10 |
| storage box, left hinged | sheet steel powder-coated RAL 7035 | 380 x 420 x 360 | | | | 30029 | 30029 2 |
| storage box, right hinged | sheet steel powder-coated RAL 7035 | 380 x 420 x 360 | | | | 30030 | 30030 2 |
| sump inliner, for shelf | polyethylene black | 1000 x 392 x 50* | | | | 7223 | 7223 2 |
| sump inliner, for drawer | PP grey | 834 x 450 x 96* | | | | 10054 | 10054 2 |
| anti-slip rubber mat, for drawer | black | 840 x 490 x 1 | | | | 8699 | 8699 2 |
| pipe lead-through | sheet steel powder-coated RAL 7035 | 182 x 104 x 48 | | | | 30035 | 30035 2 |
| base cover, with adjusting aids | panel melamine resin-coated RAL 7016 | | | | | 31005 | 31005 2 |
| base cover | panel melamine resin-coated RAL 7016 | | | | | 31925 | 31925 2 |
| Q-mover, 2 pieces | steel powder-coated textured RAL 7016 | 600 x 140 x 130 | 450.00 | | | 30037 | 30037 2 |
| box for chemicals | PP blue | 410 x 300 x 260 | | 18.00 | 16.36 | 30038 | 30038 2 |

| Accessories | Order No. |
|---|-------------------------|
| recirculating air filter system with exhaust air monitoring | 25099 2 |
| extraction unit without exhaust air monitoring | 14218 2 |

* usable storage space W x D (mm)

1) load capacity (kg), 2) retention capacity (ltr), 3) maximum container volume in the cabinet (ltr)

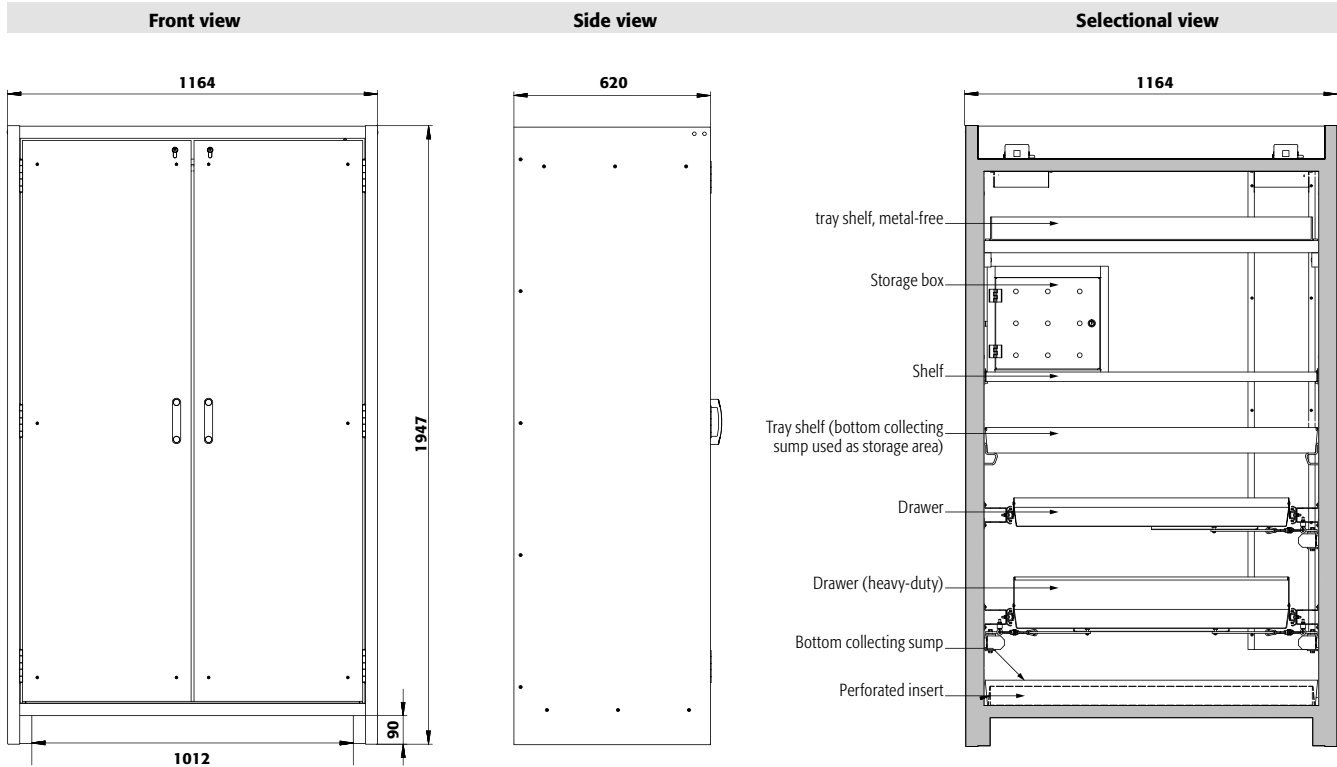

Technical data

Q30.195.116

| | | |
|--|-------------------|-------------------|
| External dimensions W x D x H | mm | 1164 x 620 x 1947 |
| Internal dimensions W x D x H | mm | 1050 x 519 x 1626 |
| Weight without interior equip. | kg | 240 |
| Air change 10 times | m ³ /h | 9 |
| Diff. pressure (air change 10 times) | Pa | 10 |
| Diff. pressure (air change 10 times EK5/AK4) | Pa | 10 |
| Maximum load | kg | 600 |
| Distributed load | kg/m ² | 445 |

Transport base

| | | |
|-----------------------------|----|------|
| Entry height transport base | mm | 90 |
| Entry width transport base | mm | 1012 |

Top view

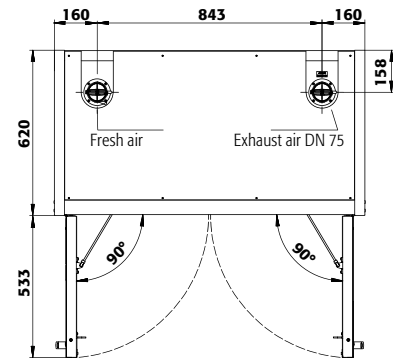

Q30.195.116

Drawers/number

| | Standard storage heights of the drawers | | | | | | | | | |
|-----------------|---|-----|-----|-----|-----|-----|-----|-----|-----|---|
| | 9 | 8 | 7 | 6 | 5 | 4+1 | 4 | 3 | 2 | 1 |
| Distance ⑨ (mm) | 130 | | | | | | | | | |
| Distance ⑧ (mm) | 135 | 130 | | | | | | | | |
| Distance ⑦ (mm) | 135 | 170 | 160 | | | | | | | |
| Distance ⑥ (mm) | 135 | 170 | 200 | 225 | | | | | | |
| Distance ⑤ (mm) | 135 | 170 | 200 | 230 | 225 | 225 | | | | |
| Distance ④ (mm) | 135 | 170 | 200 | 230 | 295 | 230 | 320 | | | |
| Distance ③ (mm) | 135 | 170 | 200 | 230 | 295 | 230 | 360 | 420 | | |
| Distance ② (mm) | 170 | 170 | 200 | 230 | 295 | 230 | 360 | 520 | 865 | |
| Distance ① (mm) | 200 | 200 | 200 | 230 | 295 | 490 | 390 | 520 | 615 | |

Q30.195.116

Shelves/number

| | Standard storage heights of the shelves | | |
|-----------------|---|-----|---|
| | 4 | 3 | 2 |
| Distance ④ (mm) | 370 | | |
| Distance ③ (mm) | 285 | 400 | |
| Distance ② (mm) | 315 | 380 | |
| Distance ① (mm) | 315 | 410 | |

Q30.195.116

Quantity

| Quantity | Type of container | Storage capacities per drawer/type of container | Container size |
|----------|--------------------------|---|----------------|
| 90 | Aerosol cans | | 400 ml |
| 40 | Cans | | 1 litre |
| 40 | Laboratory glass bottles | | 1 litre |
| 40 | Laboratory PE-bottles | | 1 litre |
| 15 | Laboratory glass bottles | | 2.5 litres |

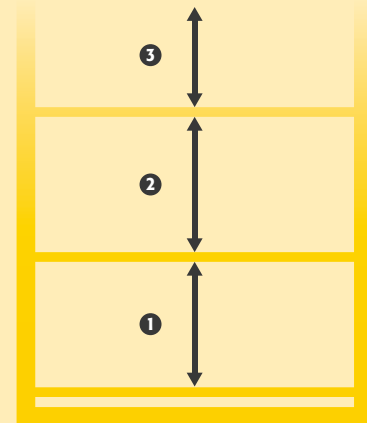

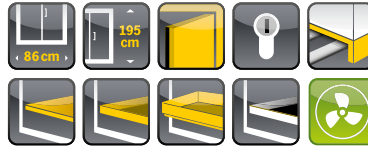

Safe and approved storage of flammable hazardous substances in working areas

Function / construction:

- **robust construction and longevity:** triple hinged door, cabinet body made of melamine resin and flame retardant special plates, safety elements assembled outside the storage compartment for increased protection against corrosion, doors with metal front as well as scratch- and impact-resistant surface, easy to clean
- **easy handling with comfort:** door stops in any position, self-closing in the event of fire
- **no unauthorised use:** door lockable with profile cylinder (integration in an existing locking system possible)
- **easy transport:** integrated transport base with removable, optional base cover or adjusting aids with base cover

- **ventilation:** integrated air ducts ready for connection (DN 75) to a technical exhaust system

Available equipment

- shelves with load capacity of 75 kg
- tray shelves with load capacity of 150 kg
- perforated insert useable as storage area
- bottom collecting sump
- drawers – high storage capacity, optimal use of the available storage capacities
- drawers heavy-duty with load capacity of 100 kg
- metal-free tray shelves and collecting sumps
- storage box
- sump inliner (PE or PP)

Safety storage cabinet

Q-CLASSIC-30 model Q30.195.086.WD

Body colour Anthracite grey, with wing door in Warning yellow (RAL 1004), interior equipment with 3 x shelf, 1 x perforated insert, 1 x bottom collecting sump (sheet steel powder-coated)

Order No. 31008-060-33622

(base cover optional)



Drawers

High storage capacity
Ideal for the storage of small containers



Metal-free interior equipment

Ideal for the storage of flammable, aggressive hazardous substances. Tray shelves with chemical resistant surface lamination and removeable plastic sump, bottom collecting plastic sump.



LARGE STORAGE CAPACITY
—
OUTSTANDING PRICE PERFORMANCE



Shelf

Height adjustable (32 mm increments), with 30 mm upstand





Safety storage cabinet

Q-CLASSIC-30 model Q30.195.086.WD

Body colour Anthracite grey, with wing door in Traffic red (RAL 3020), interior equipment with 4 x drawer (sheet steel powder-coated)

Order No. 31008-066-33627

(base cover and extraction unit optional)

Safety storage cabinet

Q-CLASSIC-30 model Q30.195.086.WD

Body colour Anthracite grey, with wing door in Light grey (RAL 7035), interior equipment with 6 x drawer (sheet steel powder-coated)

Order No. 31008-061-33629

(base cover optional)

7 door colours are available **at no extra cost:**



Order example - how to order correctly



| Model | Information / equipment | Order No. |
|-----------------|--|-----------|
| Q30.195.086.WD | without interior equipment, left hinged | 31008 |
| Q30.195.086.WDR | without interior equipment, right hinged | 31009 |









| Body colour | Door colour | Order No. |
|-----------------|-------------------------|-----------|
| Anthracite grey | Warning yellow RAL 1004 | 060 |
| Anthracite grey | Light grey RAL 7035 | 061 |
| Anthracite grey | Traffic red RAL 3020 | 066 |
| Anthracite grey | Gentian blue RAL 5010 | 067 |
| Anthracite grey | Reseda green RAL 6011 | 068 |
| Anthracite grey | asescos silver | 069 |
| Anthracite grey | Pure white RAL 9010 | 070 |













































| Interior equipment packages (can only be ordered in combination with the cabinet) | Material | Order No. |
|---|------------------------------------|-------------------------------|
| 3x shelf, 1x perforated insert, 1x bottom collecting sump (V=22.0L) | sheet steel powder-coated RAL 7035 | old code 30043 new code 33622 |
| 4x shelf, 1x perforated insert, 1x bottom collecting sump (V=22.0L) | sheet steel powder-coated RAL 7035 | 30044 33623 |
| 3x shelf, 1x bottom collecting sump (V=22.0L) | sheet steel powder-coated RAL 7035 | 30045 33624 |
| 4x shelf, 1x bottom collecting sump (V=22.0L) | sheet steel powder-coated RAL 7035 | 30046 33625 |
| 3x shelf, 1x perforated insert, 1x bottom collecting sump (V=22.0L) | stainless steel | 30047 30047 |
| 4x shelf, 1x perforated insert, 1x bottom collecting sump (V=22.0L) | stainless steel | 30048 30048 |
| 3x shelf, 1x bottom collecting sump (V=22.0L) | stainless steel | 30049 30049 |
| 4x shelf, 1x bottom collecting sump (V=22.0L) | stainless steel | 30050 30050 |
| 3x tray shelf (V=22.0L), 1x bottom collecting sump (V=22.0L) | PP grey | HIGHLIGHT 30051 30051 |
| 4x tray shelf (V=22.0L), 1x bottom collecting sump (V=22.0L) | PP grey | HIGHLIGHT 30052 30052 |
| 4x drawer (V=19.0L) | sheet steel powder-coated RAL 7035 | 30053 33627 |
| 5x drawer (V=19.0L) | sheet steel powder-coated RAL 7035 | 30054 33628 |
| 6x drawer (V=19.0L) | sheet steel powder-coated RAL 7035 | 30055 33629 |
| 4x drawer (V=19.0L) | stainless steel | 30056 33631 |
| 5x drawer (V=19.0L) | stainless steel | 30057 33632 |
| 6x drawer (V=19.0L) | stainless steel | 30058 33633 |



Individual configuration of model Q30.195.086.WD

|  Model | Information / equipment | W x D x H (mm) | Order No. |
|---|--|------------------|-----------|
| Q30.195.086.WD | without interior equipment, left hinged | 864 x 620 x 1947 | 31008 |
| Q30.195.086.WDR | without interior equipment, right hinged | 864 x 620 x 1947 | 31009 |

|  Body colour | Door colour | Order No. |
|---|-------------------------|---|
| Anthracite grey | Warning yellow RAL 1004 | 060  |
| Anthracite grey | Light grey RAL 7035 | 061  |
| Anthracite grey | Traffic red RAL 3020 | 066  |
| Anthracite grey | Gentian blue RAL 5010 | 067  |
| Anthracite grey | Reseda green RAL 6011 | 068  |
| Anthracite grey | asecos silver | 069  |
| Anthracite grey | Pure white RAL 9010 | 070  |

|  Interior equipment | Material | W x D x H (mm) |  ¹⁾ |  ²⁾ |  ³⁾ | Order No. | |
|--|---------------------------------------|------------------|---|---|---|-----------|---|
| | | | | | | old code | new code |
|  shelf | sheet steel powder-coated RAL 7035 | 740 x 432 x 30* | 75.00 | | | 30059 | 30059  |
| | stainless steel | 740 x 432 x 30* | 75.00 | | | 30061 | 30061  |
|  tray shelf, metal-free | PP grey | 702 x 472 x 74* | 50.00 | 23.00 | 20.91 | 30063 | 30063  |
|  perforated insert | sheet steel powder-coated RAL 7035 | 742 x 417 x 70 | 75.00 | | | 11165 | 11165  |
| | stainless steel | 742 x 417 x 70 | 75.00 | | | 11168 | 11168  |
|  bottom collecting sump | sheet steel powder-coated RAL 7035 | 724 x 489 x 83* | | 22.00 | 20.00 | 30060 | 33621  |
|  drawer | sheet steel powder-coated RAL 7035 | 544 x 488 x 90* | 60.00 | 19.00 | 1727 | 30065 | 33626  |
|  bottom collecting sump | stainless steel | 724 x 489 x 83* | | 23.00 | 20.91 | 30062 | 30062  |
|  bottom collecting sump, metal-free | PP grey | 702 x 472 x 74* | | 23.00 | 20.91 | 26990 | 26990  |
|  drawer | stainless steel | 544 x 488 x 90* | 60.00 | 19.00 | 1727 | 30067 | 33630  |
|  drawer (heavy-duty) | sheet steel powder-coated RAL 7035 | 543 x 487 x 162* | 100.00 | 45.00 | | 30066 | 30066  |
| | stainless steel | 543 x 487 x 162* | 100.00 | 45.00 | | 30068 | 30068  |
|  storage box, left hinged | sheet steel powder-coated RAL 7035 | 380 x 420 x 360 | | | | 30029 | 30029  |
|  storage box, right hinged | sheet steel powder-coated RAL 7035 | 380 x 420 x 360 | | | | 30030 | 30030  |
|  sump inliner, for drawer | polyethylene white | 536 x 480 x 90* | | 22.00 | 20.00 | 27948 | 27948  |
|  sump inliner, for shelf | PP grey | 653 x 406 x 88* | | | | 9707 | 9707  |
|  anti-slip rubber mat, for drawer | black | 540 x 490 x 1 | | | | 15653 | 15653  |
|  pipe lead-through | sheet steel powder-coated RAL 7035 | 182 x 104 x 48 | | | | 30035 | 30035  |
|  base cover, with adjusting device (available for order only in combination with cabinet) | panel melamine resin-coated RAL 7016 | | | | | 31010 | 31010  |
|  base cover | panel melamine resin-coated RAL 7016 | | | | | 31924 | 31924  |
|  Q-mover, 2 pieces | steel powder-coated textured RAL 7016 | 600 x 140 x 130 | 450.00 | | | 30037 | 30037  |
|  box for chemicals | PP blue | 410 x 300 x 260 | | 18.00 | 16.36 | 30038 | 30038  |

|  Accessories | Order No. |
|---|---|
| recirculating air filter system with exhaust air monitoring | 25099  |
| extraction unit without exhaust air monitoring | 14218  |

* usable storage space W x D [mm]
1) load capacity (kg), 2) retention capacity (ltr), 3) maximum container volume in the cabinet (ltr)

CERTIFIED SAFETY 
YOU CAN RELY ON.

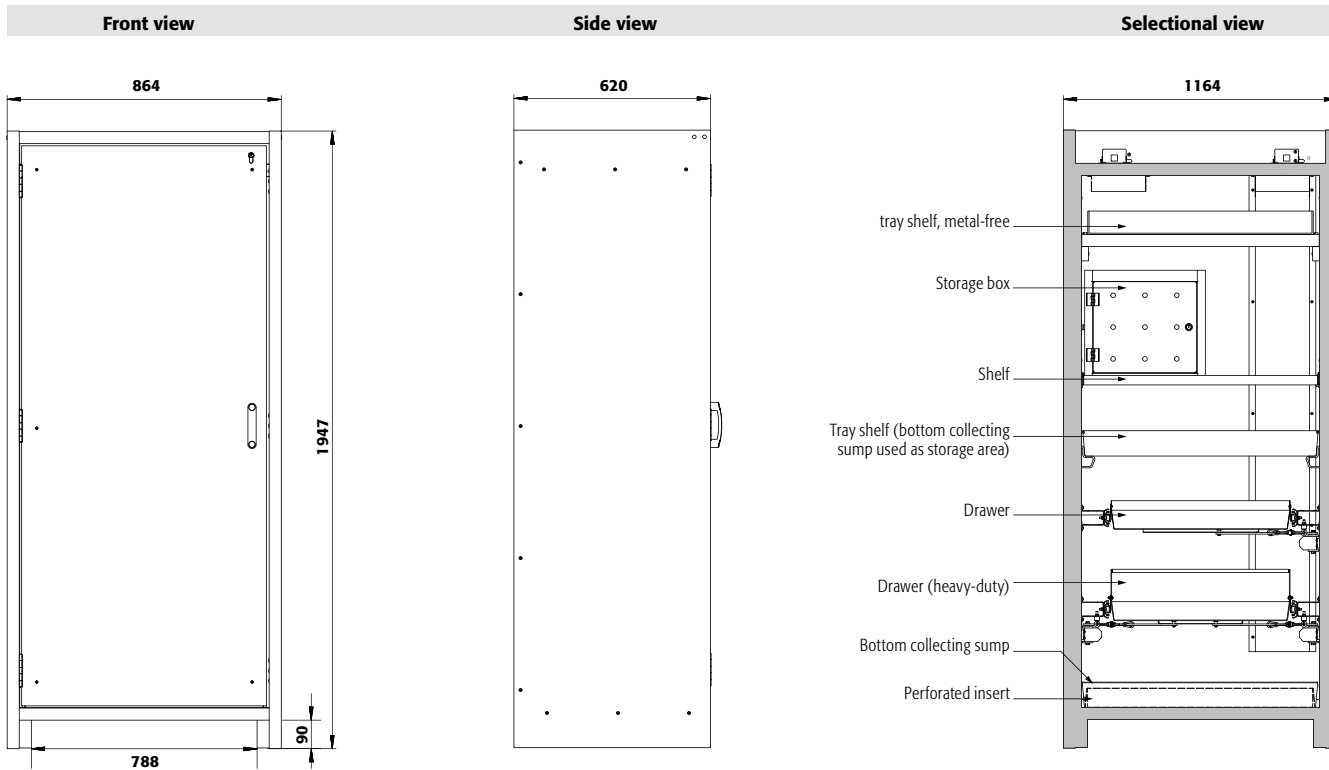

Technical data

Q30.195.086.WD

| | | |
|--|-------------------|------------------|
| External dimensions W x D x H | mm | 864 x 620 x 1947 |
| Internal dimensions W x D x H | mm | 750 x 519 x 1626 |
| Weight without interior equip. | kg | 195 |
| Air change 10 times | m ³ /h | 6 |
| Diff. pressure (air change 10 times) | Pa | 10 |
| Diff. pressure (air change 10 times EK5/AK4) | Pa | 10 |
| Maximum load | kg | 600 |
| Distributed load | kg/m ² | 568 |

Transport base

| | | |
|-----------------------------|----|-----|
| Entry height transport base | mm | 90 |
| Entry width transport base | mm | 788 |

Top view

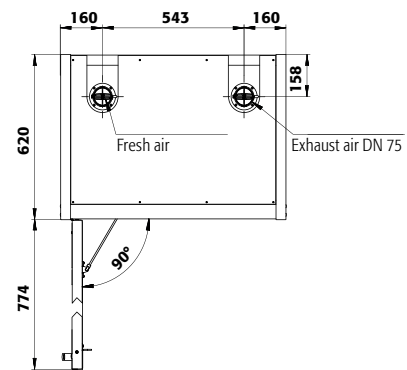

Q30.195.086.WD

Drawers/number

| | 9 | 8 | 7 | 6 | 5 | 4+1 | 4 | 3 | 2 |
|-----------------|-----|-----|-----|-----|-----|-----|-----|-----|-----|
| Distance ⑨ (mm) | 130 | | | | | | | | |
| Distance ⑧ (mm) | 135 | 130 | | | | | | | |
| Distance ⑦ (mm) | 135 | 170 | 160 | | | | | | |
| Distance ⑥ (mm) | 135 | 170 | 200 | 225 | | | | | |
| Distance ⑤ (mm) | 135 | 170 | 200 | 230 | 225 | 225 | | | |
| Distance ④ (mm) | 135 | 170 | 200 | 230 | 295 | 230 | 320 | | |
| Distance ③ (mm) | 135 | 170 | 200 | 230 | 295 | 230 | 360 | 420 | |
| Distance ② (mm) | 170 | 170 | 200 | 230 | 295 | 230 | 360 | 520 | 865 |
| Distance ① (mm) | 200 | 200 | 200 | 230 | 295 | 490 | 390 | 520 | 615 |

Q30.195.086.WD

Shelves/number

| | 4 | 3 |
|-----------------|-----|-----|
| Distance ④ (mm) | 370 | |
| Distance ③ (mm) | 285 | 400 |
| Distance ② (mm) | 315 | 380 |
| Distance ① (mm) | 315 | 410 |

Q30.195.086.WD

Quantity

| Quantity | Type of container | Container size |
|----------|--------------------------|----------------|
| 49 | Aerosol cans | 400 ml |
| 23 | Cans | 1 litre |
| 23 | Laboratory glass bottles | 1 litre |
| 23 | Laboratory PE-bottles | 1 litre |
| 9 | Laboratory glass bottles | 2.5 litres |

Standard storage heights of the drawers

9 8 7 6 5 4+1 4 3 2

Standard storage heights of the shelves

4 3

Storage capacities per drawer/type of container

| Type of container | Container size |
|--------------------------|----------------|
| Aerosol cans | 400 ml |
| Cans | 1 litre |
| Laboratory glass bottles | 1 litre |
| Laboratory PE-bottles | 1 litre |
| Laboratory glass bottles | 2.5 litres |

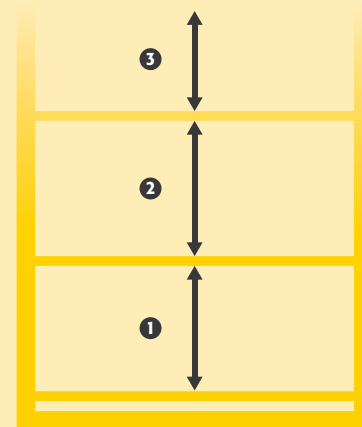

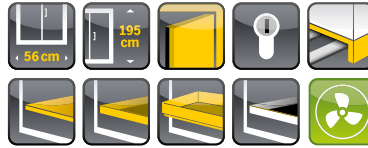

Safe and approved storage of flammable hazardous substances in working areas

Function / construction:

- **robust construction and longevity:** triple hinged door, cabinet body made of melamine resin and flame retardant special plates, safety elements assembled outside the storage compartment for increased protection against corrosion, doors with metal front as well as scratch- and impact-resistant surface, easy to clean
- **easy handling with comfort:** door stops in any position, self-closing in the event of fire
- **no unauthorised use:** door lockable with profile cylinder (integration in an existing locking system possible)
- **easy transport:** integrated transport base with removable, optional base cover or adjusting aids with base cover

- **ventilation:** integrated air ducts ready for connection (DN 75) to a technical exhaust system

Available equipment

- shelves with load capacity of 75 kg
- tray shelves with load capacity of 150 kg
- perforated insert useable as storage area
- bottom collecting sump
- drawers – high storage capacity, optimal use of the available storage capacities
- drawers heavy-duty with load capacity of 100 kg
- metal-free tray shelves and collecting sumps
- storage box
- sump inliner (PE or PP)

Safety storage cabinet

Q-CLASSIC-30 model Q30.195.056

Body colour Anthracite grey, with wing door in Warning yellow (RAL 1004), interior equipment with 3 x shelf, 1 x perforated insert, 1 x bottom collecting sump (sheet steel powder-coated)

Order No. 31002-060-33600

(base cover and extraction unit optional)



Drawers

High storage capacity
Ideal for the storage of small containers



Shelf

Height adjustable (32 mm increments), with 30 mm upstand



Extraction unit

Safe ventilation of safety storage cabinets

plug-in – fast and easy to install

Further information and products from page 397

Order No. 14218



Metal-free interior equipment

Ideal for the storage of flammable, aggressive hazardous substances. Tray shelves with chemical resistant surface lamination and removeable plastic sump, bottom collecting plastic sump.



Recirculating air filter system

Avoid complex wall breakthroughs and expensive extraction piping

Further information from page 393

Order No. 25099



Safety storage cabinet

Q-CLASSIC-30 model Q30.195.056

Body colour Anthracite grey, with wing door in Traffic red (RAL 3020), interior equipment with 4 x drawer (sheet steel powder-coated)

Order No. 31002-066-33608

(base cover optional)

Safety storage cabinet

Q-CLASSIC-30 model Q30.195.056

Body colour Anthracite grey, with wing door in Light grey (RAL 7035), interior equipment with 6 x drawer (sheet steel powder-coated)

Order No. 31002-061-33610

(recirculating air filter system optional)

7 door colours are available **at no extra cost:**



Order example - how to order correctly



| Model | Information / equipment | Order No. |
|---------------|--|-----------|
| Q30.195.056 | without interior equipment, left hinged | 31002 |
| Q30.195.056.R | without interior equipment, right hinged | 31007 |









| Body colour | Door colour | Order No. |
|-----------------|-------------------------|-----------|
| Anthracite grey | Warning yellow RAL 1004 | 060 |
| Anthracite grey | Light grey RAL 7035 | 061 |
| Anthracite grey | Traffic red RAL 3020 | 066 |
| Anthracite grey | Gentian blue RAL 5010 | 067 |
| Anthracite grey | Reseda green RAL 6011 | 068 |
| Anthracite grey | asecos silver | 069 |
| Anthracite grey | Pure white RAL 9010 | 070 |





















































| Interior equipment packages (can only be ordered in combination with the cabinet) | Material | Order No. |
|--|------------------------------------|------------------------------|
| | | old code new code |
| 3x shelf, 1x perforated insert, 1x bottom collecting sump (V=22.0L) | sheet steel powder-coated RAL 7035 | 30076 33600 |
| 4x shelf, 1x perforated insert, 1x bottom collecting sump (V=22.0L) | sheet steel powder-coated RAL 7035 | 30077 33602 |
| 3x shelf, 1x bottom collecting sump (V=22.0L) | sheet steel powder-coated RAL 7035 | 30078 33603 |
| 4x shelf, 1x bottom collecting sump (V=22.0L) | sheet steel powder-coated RAL 7035 | 30079 33604 |
| 3x tray shelf (V=12.0L), 1x perforated insert, 1x bottom collecting sump (V=33.0L) | sheet steel powder-coated RAL 7035 | 30080 33606 |
| 3x shelf, 1x perforated insert, 1x bottom collecting sump (V=22.0L) | stainless steel | 30081 30081 |
| 4x shelf, 1x perforated insert, 1x bottom collecting sump (V=22.0L) | stainless steel | 30082 30082 |
| 3x shelf, 1x bottom collecting sump (V=22.0L) | stainless steel | 30083 30083 |
| 4x shelf, 1x bottom collecting sump (V=22.0L) | stainless steel | 30084 30084 |
| 3x tray shelf (V=12.0L), 1x perforated insert, 1x bottom collecting sump (V=33.0L) | stainless steel | 30085 30085 |
| 3x tray shelf (V=11.0L), 1x bottom collecting sump (V=11.0L) | PP grey | HIGHLIGHT 30086 30086 |
| 4x tray shelf (V=11.0L), 1x bottom collecting sump (V=11.0L) | PP grey | HIGHLIGHT 30087 30087 |
| 4x drawer (V=5.0L) | sheet steel powder-coated RAL 7035 | 30088 33608 |
| 5x drawer (V=5.0L) | sheet steel powder-coated RAL 7035 | 30089 33609 |
| 6x drawer (V=5.0L) | sheet steel powder-coated RAL 7035 | 30090 33610 |
| 3x drawer (V=5.0L), 1x drawer (disposal) (V=30.0L) | sheet steel powder-coated RAL 7035 | 30091 33612 |
| 4x drawer (V=5.0L), 1x drawer (disposal) (V=30.0L) | sheet steel powder-coated RAL 7035 | 30092 33613 |
| 4x drawer (V=5.0L) | stainless steel | 30093 33616 |
| 5x drawer (V=5.0L) | stainless steel | 30094 33617 |
| 6x drawer (V=5.0L) | stainless steel | 30095 33618 |
| 3x drawer (V=5.0L), 1x drawer (disposal) (V=30.0L) | stainless steel | 30096 33619 |
| 4x drawer (V=5.0L), 1x drawer (disposal) (V=30.0L) | stainless steel | 30097 33620 |



Individual configuration of model Q30.195.056

|  Model | Information / equipment | W x D x H (mm) | Order No. |
|---|--|------------------|-----------|
| Q30.195.056 | without interior equipment, left hinged | 564 x 620 x 1947 | 31002 |
| Q30.195.056.R | without interior equipment, right hinged | 564 x 620 x 1947 | 31007 |

|  Body colour | Door colour | Order No. |
|---|-------------------------|---|
| Anthracite grey | Warning yellow RAL 1004 | 060  |
| Anthracite grey | Light grey RAL 7035 | 061  |
| Anthracite grey | Traffic red RAL 3020 | 066  |
| Anthracite grey | Gentian blue RAL 5010 | 067  |
| Anthracite grey | Reseda green RAL 6011 | 068  |
| Anthracite grey | asecos silver | 069  |
| Anthracite grey | Pure white RAL 9010 | 070  |

|  Interior equipment | Material | W x D x H (mm) |  1) |  2) |  3) | Order No. | |
|---|---------------------------------------|------------------|--|--|--|-----------|---|
| | | | | | | old code | new code |
|  shelf | sheet steel powder-coated RAL 7035 | 440 x 432 x 30* | 75.00 | | | 30098 | 30098  |
| | stainless steel | 440 x 432 x 30* | 75.00 | | | 30102 | 30102  |
|  tray shelf | sheet steel powder-coated RAL 7035 | 427 x 442 x 70* | 150.00 | 12.00 | 10.91 | 30099 | 30099  |
| | stainless steel | 427 x 442 x 70* | 150.00 | 12.00 | 10.91 | 30103 | 30103  |
|  tray shelf, metal-free | PP grey | 424 x 472 x 67* | 50.00 | 13.00 | 11.82 | 30106 | 30106  |
|  perforated insert | sheet steel powder-coated RAL 7035 | 420 x 439 x 60 | 75.00 | | | 5555 | 5555  |
| | stainless steel | 425 x 439 x 60 | 75.00 | | | 5776 | 5776  |
|  bottom collecting sump | sheet steel powder-coated RAL 7035 | 442 x 507 x 127 | | 22.00 | 20.00 | 30100 | 33594  |
| | stainless steel | 418 x 433 x 120* | | 22.00 | 20.00 | 30104 | 30104  |
|  bottom collecting sump, metal-free | PP grey | 422 x 472 x 67* | | 12.50 | 11.36 | 25424 | 25424  |
|  bottom collecting sump, height = 180 mm | sheet steel powder-coated RAL 7035 | 409 x 474 x 171* | | 33.00 | 30.00 | 30101 | 33605  |
|  bottom collecting sump, height = 170 mm | stainless steel | 439 x 454 x 170* | | 33.00 | 30.00 | 30105 | 30105  |
|  drawer | sheet steel powder-coated RAL 7035 | 345 x 500 x 50* | 25.00 | 5.00 | 4.55 | 30108 | 33607  |
| | stainless steel | 345 x 500 x 50* | 25.00 | 5.00 | 4.55 | 30110 | 33614  |
|  drawer (disposal) | sheet steel powder-coated RAL 7035 | 329 x 462 x 200* | 50.00 | 30.00 | | 30109 | 30109  |
| | stainless steel | 329 x 462 x 150* | 50.00 | 30.00 | | 30111 | 30111  |
|  storage box, left hinged | sheet steel powder-coated RAL 7035 | 380 x 420 x 360 | | | | 30029 | 30029  |
|  storage box, right hinged | sheet steel powder-coated RAL 7035 | 380 x 420 x 360 | | | | 30030 | 30030  |
|  sump inliner, for drawer disposal | PP grey | 318 x 449 x 66* | | | | 18472 | 18472  |
|  sump inliner | PP grey | 353 x 406 x 88* | | | | 9706 | 9706  |
|  sump inliner, for drawer disposal | PP black | 313 x 413 x 171* | | | | 18474 | 18474  |
|  anti-slip rubber mat, for drawer disposal | black | 495 x 340 x 1 | | | | 8719 | 8719  |
|  pipe lead-through | sheet steel powder-coated RAL 7035 | 182 x 104 x 48 | | | | 30035 | 30035  |
|  base cover, with adjusting aids | panel melamine resin-coated RAL 7016 | 488 x NaN | | | | 31004 | 31004  |
|  base cover | panel melamine resin-coated RAL 7016 | | | | | 31923 | 31923  |
|  Q-mover, 2 pieces | steel powder-coated textured RAL 7016 | 600 x 140 x 130 | 450.00 | | | 30037 | 30037  |
|  box for chemicals | PP blue | 410 x 300 x 260 | | 18.00 | 16.36 | 30038 | 30038  |

|  Accessories | Order No. |
|---|---|
| recirculating air filter system with exhaust air monitoring | 25099  |
| extraction unit without exhaust air monitoring | 14218  |

* usable storage space W x D (mm)
 1) load capacity (kg), 2) retention capacity (ltr), 3) maximum container volume in the cabinet (ltr)

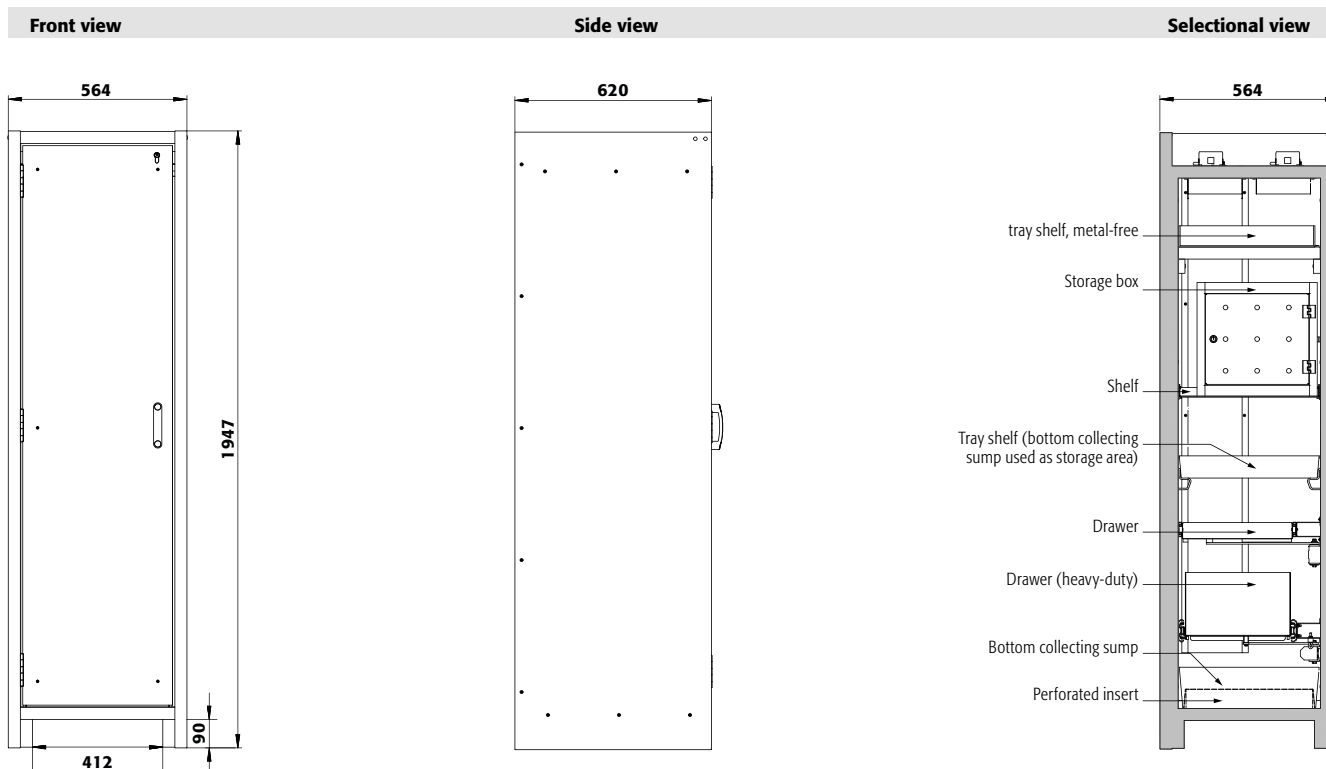

Technical data

Q30.195.056

| | | |
|--|-------------------|------------------|
| External dimensions W x D x H | mm | 564 x 620 x 1947 |
| Internal dimensions W x D x H | mm | 450 x 519 x 1626 |
| Weight without interior equip. | kg | 146 |
| Air change 10 times | m ³ /h | 4 |
| Diff. pressure (air change 10 times) | Pa | 10 |
| Diff. pressure (air change 10 times EK5/AK4) | Pa | 10 |
| Maximum load | kg | 600 |
| Distributed load | kg/m ² | 816 |

Transport base

| | | |
|-----------------------------|----|-----|
| Entry height transport base | mm | 90 |
| Entry width transport base | mm | 412 |

Top view

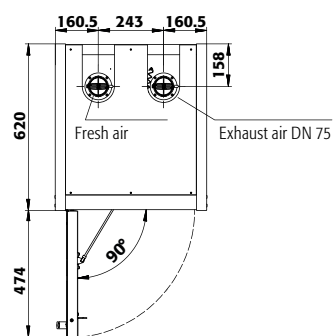

Q30.195.056

Drawers/number

| | 9 | 8 | 7 | 6 | 5 | 4 | 3 | 2 |
|-----------------|-----|-----|-----|-----|-----|-----|-----|-----|
| Distance ⑨ (mm) | 125 | | | | | | | |
| Distance ⑧ (mm) | 135 | 125 | | | | | | |
| Distance ⑦ (mm) | 135 | 170 | 155 | | | | | |
| Distance ⑥ (mm) | 135 | 170 | 200 | 220 | | | | |
| Distance ⑤ (mm) | 135 | 170 | 200 | 230 | 220 | | | |
| Distance ④ (mm) | 135 | 170 | 200 | 230 | 295 | 315 | | |
| Distance ③ (mm) | 135 | 170 | 200 | 230 | 295 | 360 | 410 | |
| Distance ② (mm) | 170 | 170 | 200 | 230 | 295 | 360 | 520 | 860 |
| Distance ① (mm) | 200 | 200 | 200 | 230 | 295 | 390 | 520 | 615 |

Standard storage heights of the drawers

Q30.195.056

Shelves/number

| | 4 | 3 |
|-----------------|-----|-----|
| Distance ④ (mm) | 370 | |
| Distance ③ (mm) | 285 | 400 |
| Distance ② (mm) | 315 | 380 |
| Distance ① (mm) | 315 | 410 |

Standard storage heights of the shelves

Q30.195.056

Quantity

| Quantity | Type of container | Container size |
|----------|--------------------------|----------------|
| 30 | Aerosol cans | 400 ml |
| 12 | Cans | 1 litre |
| 12 | Laboratory glass bottles | 1 litre |
| 12 | Laboratory PE-bottles | 1 litre |
| 6 | Laboratory glass bottles | 2.5 litres |

Storage capacities per drawer/type of container

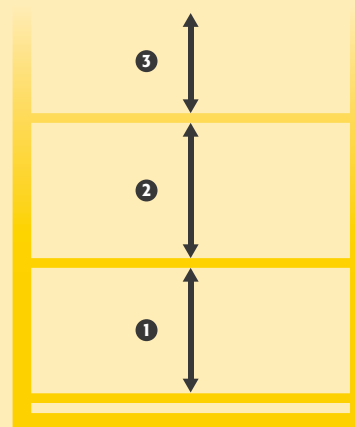



WolfLabs

Pricing on any accessories shown can be found by keying the part number into the search box on our website.

The specifications listed in this brochure are subject to change by the manufacturer and therefore cannot be guaranteed to be correct. If there are aspects of the specification that must be guaranteed, please provide these to our sales team so that details can be confirmed.

www.wolflabs.co.uk

Tel : 01759 301142

Fax : 01759 301143

sales@wolflabs.co.uk

Please contact us if this literature doesn't answer all your questions.